

SIT STAND DESK

INNOVATIVE PNEUMATIC ADJUSTMENT

SIT-STAND

Standing desks are well known to help improve mood and energy levels as well as increase productivity. With the flip of a lever, the Alumni Sit-Stand Desk pneumatically adjusts from sit to stand (26-43"). Endless position changes throughout the day make this desk an energetic addition to any learning environment. Two casters and two stabilizing glides make this desk easy to move around the classroom and set in place.



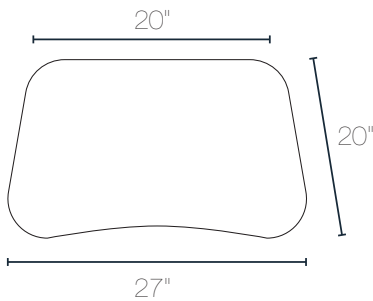









TOP	Collaborative 20"x27" hard plastic top with embossed pencil groove
FRAME	Heavy gauge steel frame with pneumatically adjusted height 26" - 43"
FINISH	100% polyester premium powder coat
GLIDES	Two casters and two stabilizing glides
AVAILABLE OPTIONS	Rectangular 20x26" hard plastic top, HPL top with PVC edge



Model	Top Size	Wt. (lbs)	Freight Class
D-SSR-2027COLLAB	20"x27"	35	150

FRAME COLOR
 Black

HARD PLASTIC TOPS

-  Sugar Maple
-  Bannister Oak
-  Wild Cherry
-  Mahogany
-  Dark Walnut
-  Beige Sand
-  Grey Sand
-  Grey Spectrum
-  Cosmic Strandz
-  Agave Blue
-  Sprout Green
-  Pomegranate Red
-  Eggplant Purple

LAMINATE TOPS

-  Sugar Maple
-  Bannister Oak
-  Wild Cherry
-  Mahogany
-  Dark Walnut
-  Grey Spectrum
-  Cosmic Strandz
-  Primary Blue
-  Primary Green
-  Primary Red
-  Primary Yellow

PVC

-  Black
-  Grey
-  Beige
-  Maple
-  Charcoal
-  Navy Blue
-  Primary Blue
-  Primary Green
-  Apple Green
-  Burgundy
-  Primary Red
-  Primary Yellow

